

MODEL **CST-30**

Instruction Manual

Thank you for purchasing our products.

For your safety :

Read this manual carefully for proper handling and operation before using.
Keep this manual in a safe place for future reference.

[Features]

- This is a connector mount base for direct mounting of ICOM IC-705 radio and YAESU FT-817ND, FT-818ND.
- The angle can be changed to match the installation angle of the radio.
- BNC-LP, SO-239 Adapter cable is included.
- Holes are provided for SMA-J and BNC-J bulkhead types to be mounted.

Notes on installation and installation

- Tighten all screws securely to prevent unexpected tipping or falling off.
- An antenna that is too long may not be able to hold its angle due to poor balance. Make sure that the antenna can withstand the installation before installing it.

[How to use]

Refer to the figure below for installation.

When attaching the bracket to YAESU FT-817ND, FT-818ND, it will be easier to attach the cable if the upper bracket direction is opposite.

Product Specifications

- ◆ Bracket dimensions : 53(W) x 32(D) x 68(H) [mm]
- ◆ Bracket weight : approx. 70g
- ◆ Material : SUS304 [Main body], Brass [Screw]
- ◆ BNC-LP to SO-239 Adapter cable
Cable length : approx. 130mm

Accessories:

- 2 screws with knurled knobs
- BNC-LP to SO-239 Adapter Cable

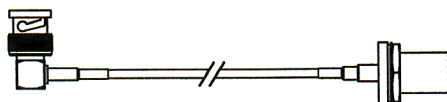

For installation on ICOM IC-705

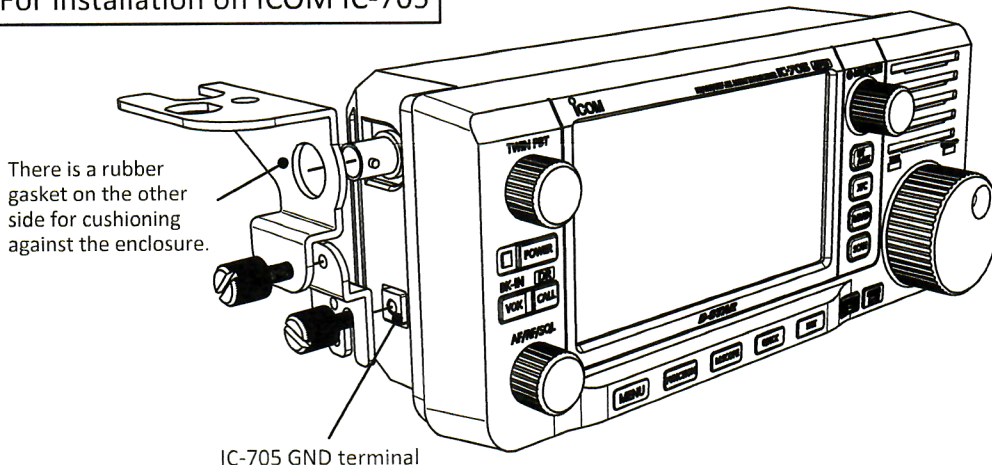

There is a rubber gasket on the other side for cushioning against the enclosure.

IC-705 GND terminal

For installation on YAESU FT-817ND, FT-818ND

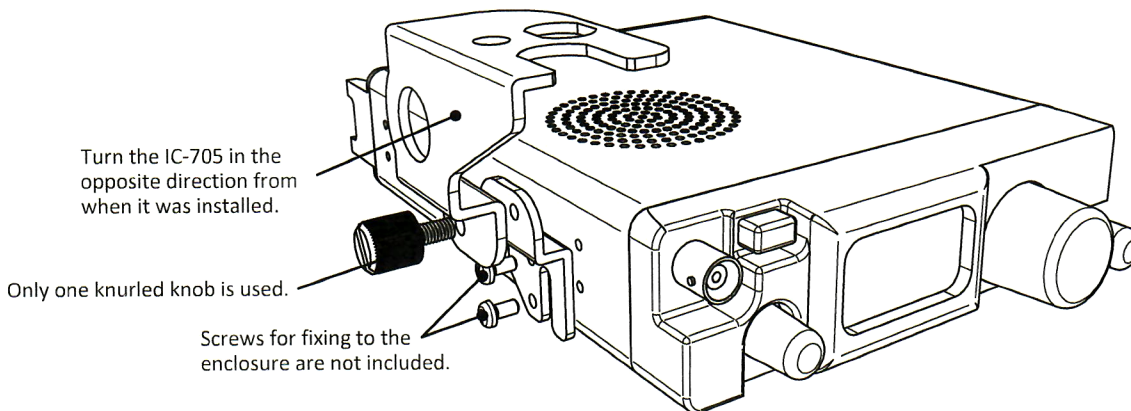

Turn the IC-705 in the opposite direction from when it was installed.

Only one knurled knob is used.

Screws for fixing to the enclosure are not included.

Assembly image : bracket only

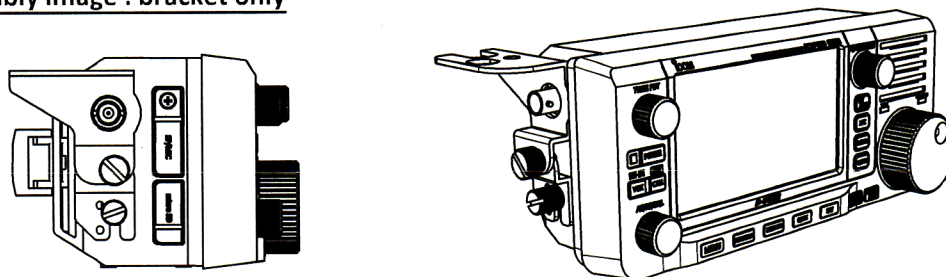

Adapter cable install image : Default position [0 degree]

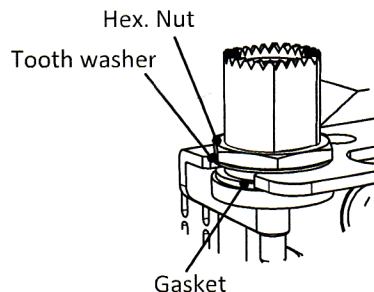
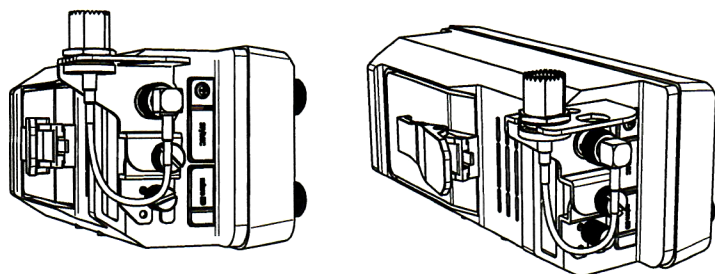

Adapter cable install image : Inclined position [Max. 30 degree]

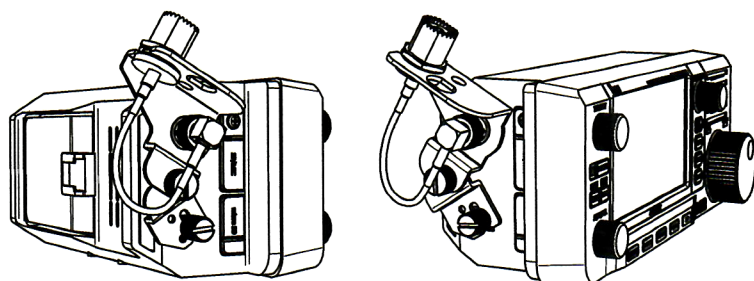

**FT-817ND, FT-818ND
Install Image**

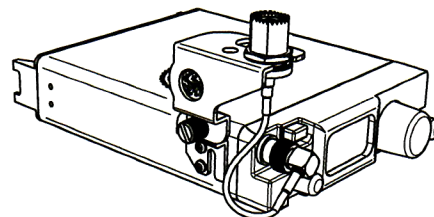

• For connector holes other than SO-239

Holes are provided to accommodate SMA-J and BNC-J bulkhead connectors.

Notice: Please note that some sizes of BNC-J bulkhead connectors are not compatible with some manufacturers.

Hole for SMA-J bulkhead

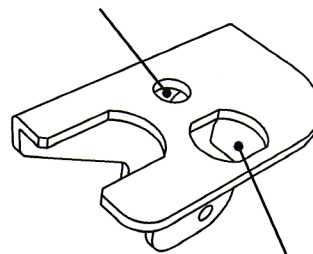

Hole for BNC-J bulkhead

⚠ Cautions

- Tighten the screws and nuts securely during installation to prevent a fall accident.
- Install in a place free from vibration and shaking so that the screws do not loosen.
- Pay attention to the weight balance when installing antennas.

[Inspection and care]

- ▼ Check the mounting screws and brackets regularly for looseness, and retighten any loose parts.
- ▼ Be sure to replace parts that have become insufficient or deformed due to changes over time.

COMET CO.,LTD.

4-18-2, Tsuji, Minami-ku, Saitama-shi, Saitama-Pref, 336-0026, JAPAN

TEL : 81-48-839-3131 / FAX : 81-48-839-3136

URL : <http://www.comet-ant.co.jp/english>

■ Specifications or appearance is subject to change without notice.

1st edition, Jan 2021. Printed in JAPAN.
Copyright (C) 2021 COMET CO.,LTD. All Rights Reserved.